

## Einbauanleitung AWRON Fxx Deleter Fxx



**M2 F87**

**M3 F80**

**M4 F82**

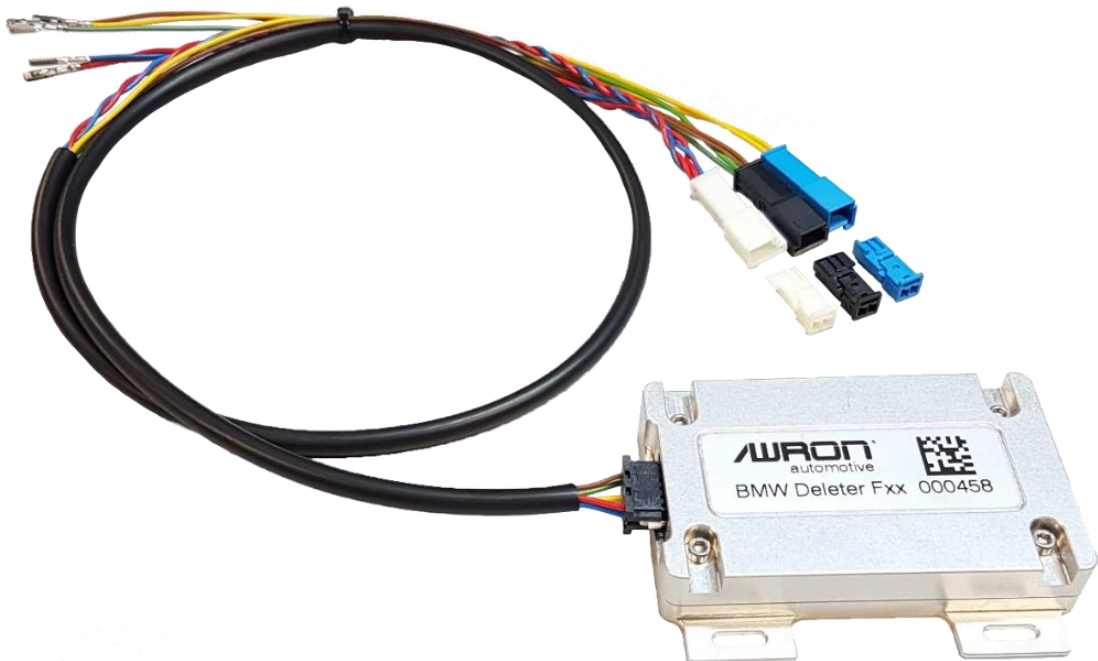

## benötigte Werkzeug

Steckschlüssel TORX T25



Steckschlüssel 10mm



Flachschraubendreher 2mm

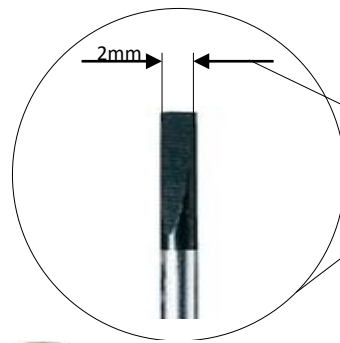

## Demontage Verkleidung unter Handschuhfach



Sechskant, Schlüsselweite 8mm



Sechskant, Schlüsselweite 8mm

## Demontage Verkleidung unter Handschuhfach



Kein Werkzeug notwendig

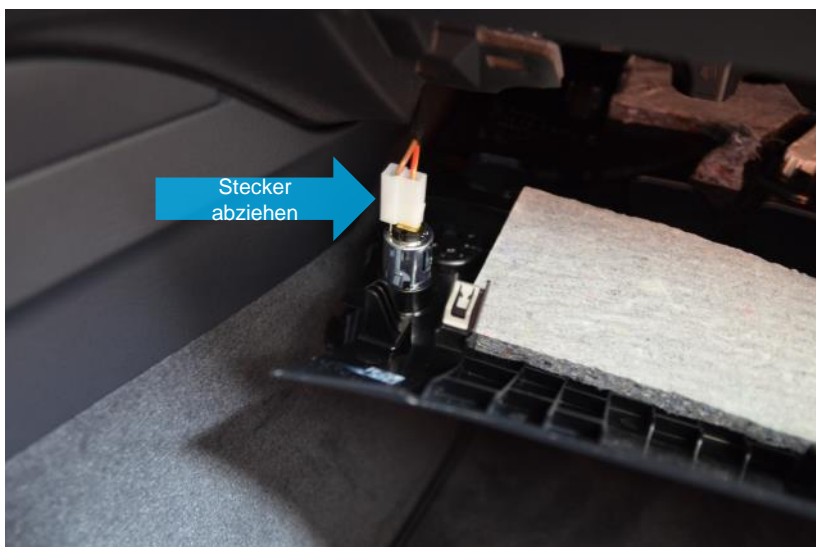

Kein Werkzeug notwendig

## Demontage Verkleidung unter Handschuhfach

---

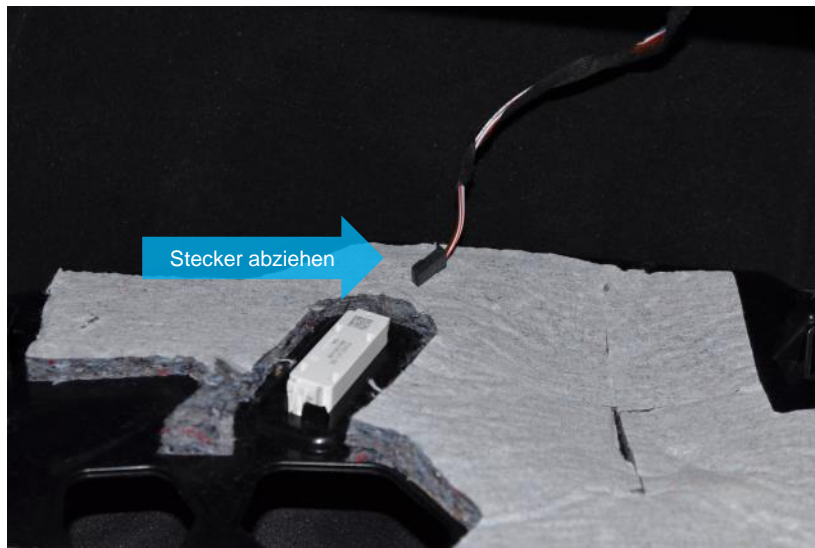

Kein Werkzeug notwendig

## Demontage Verkleidung unter Handschuhfach



Kunststoffkeil verwenden



Kunststoffkeil verwenden

## Demontage Seitenverkleidung Beifahrerseite



Kunststoffkeil verwenden

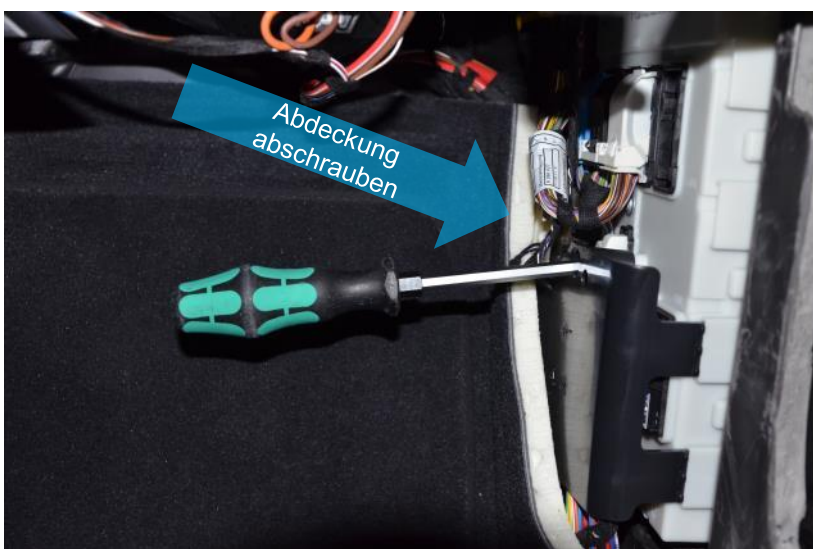

Torx T25

## Freilegung der Stecker am FEM Steuergerät

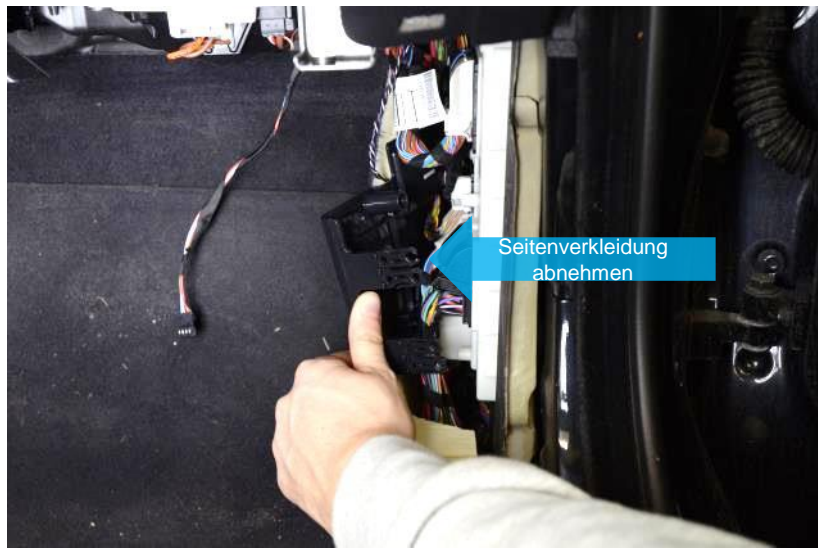

Kein Werkzeug notwendig

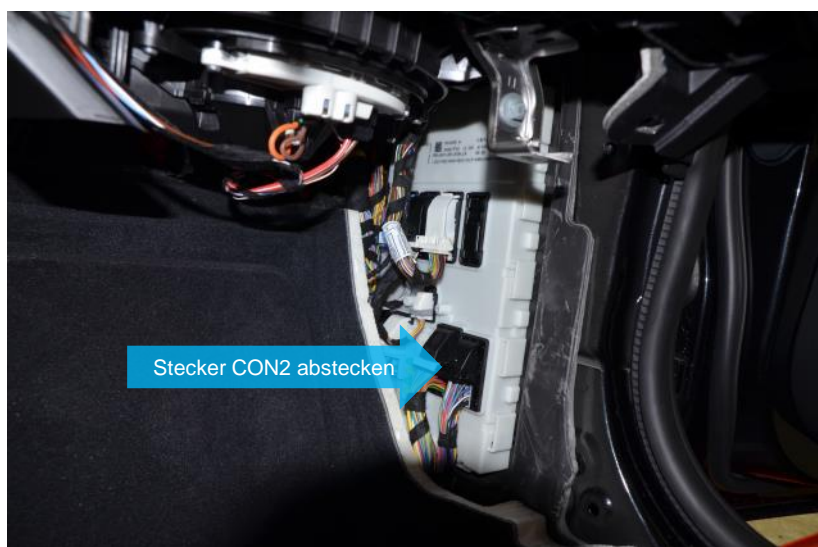

Kein Werkzeug notwendig



## Stecker CON 3 demontieren

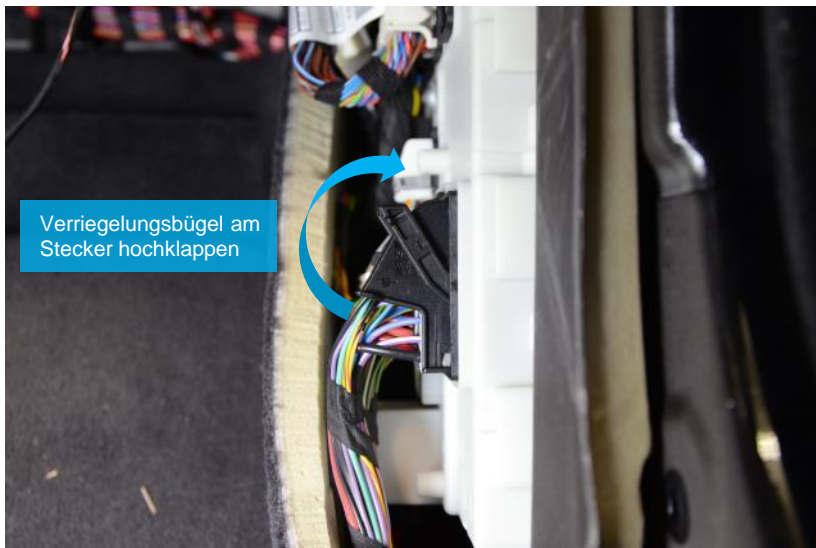

Kein Werkzeug notwendig

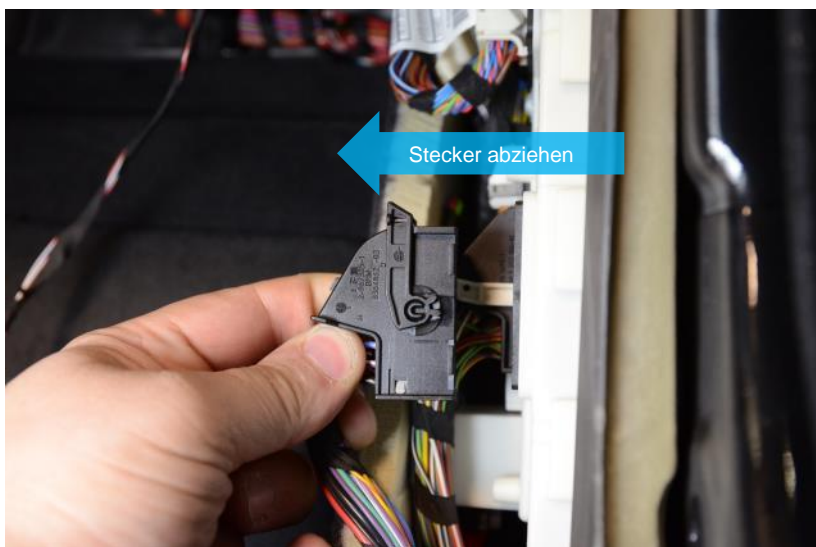

Kein Werkzeug notwendig

## FEM/BDC CON 3

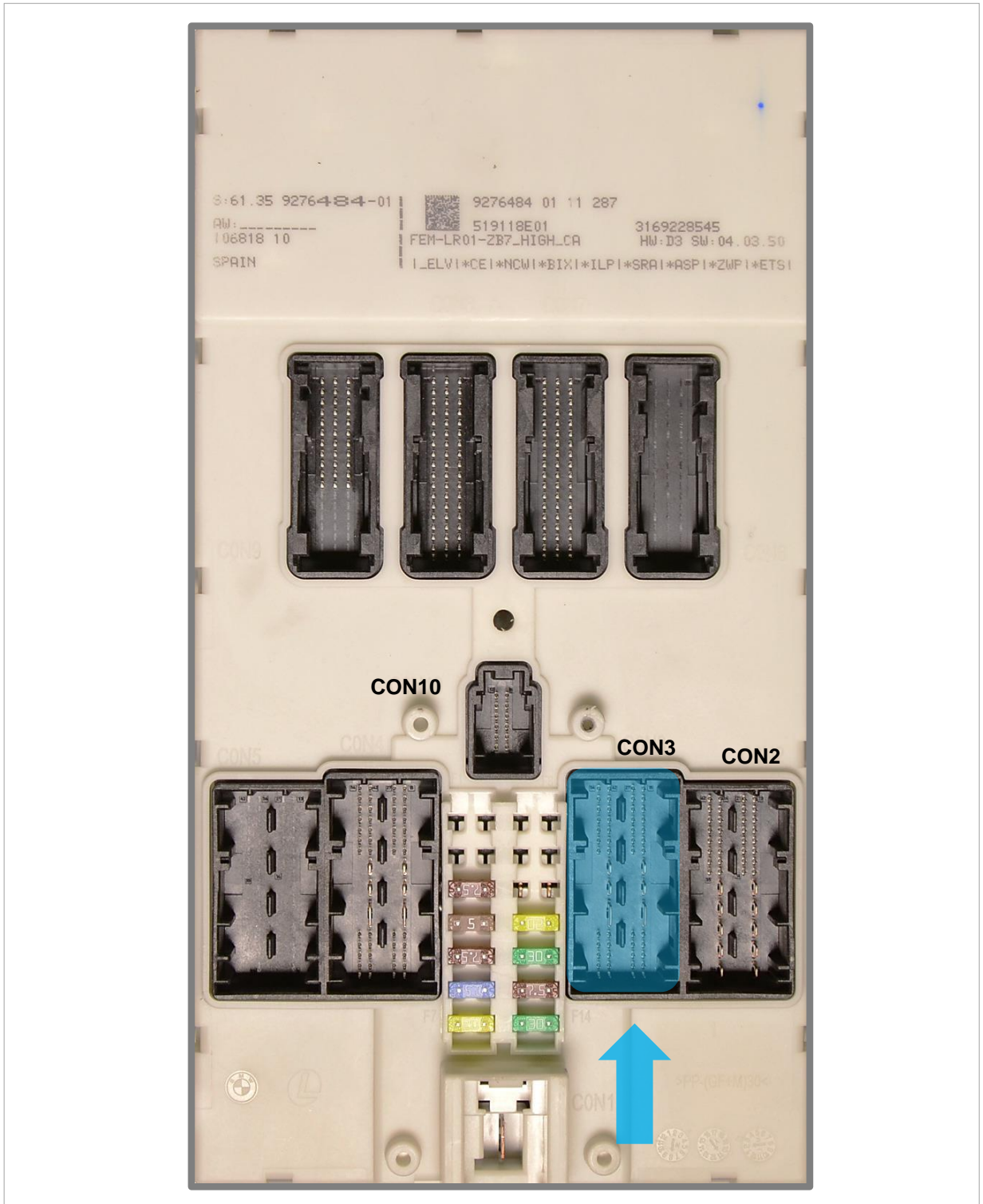

## Kabel aus Kammer ausspinnen



Kein Werkzeug notwendig

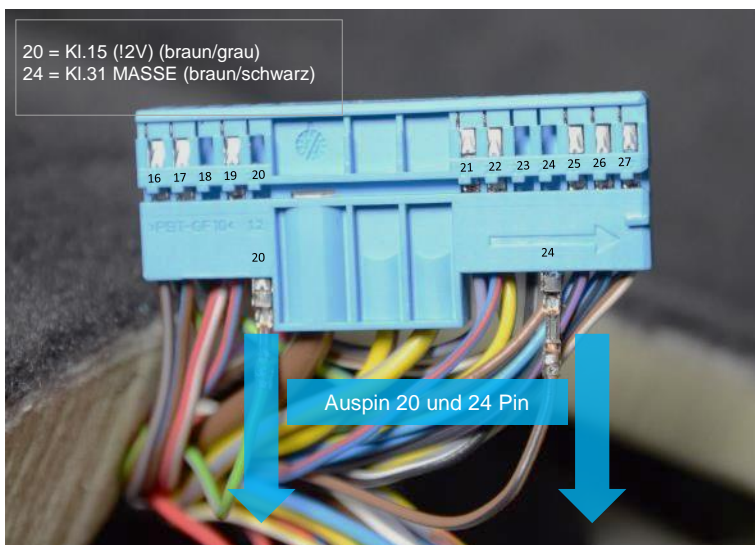

Flachschraubenzieher 2mm

## Kabel in Stecker pinnen und zusammenstecken



## FEM/BDC CON 3

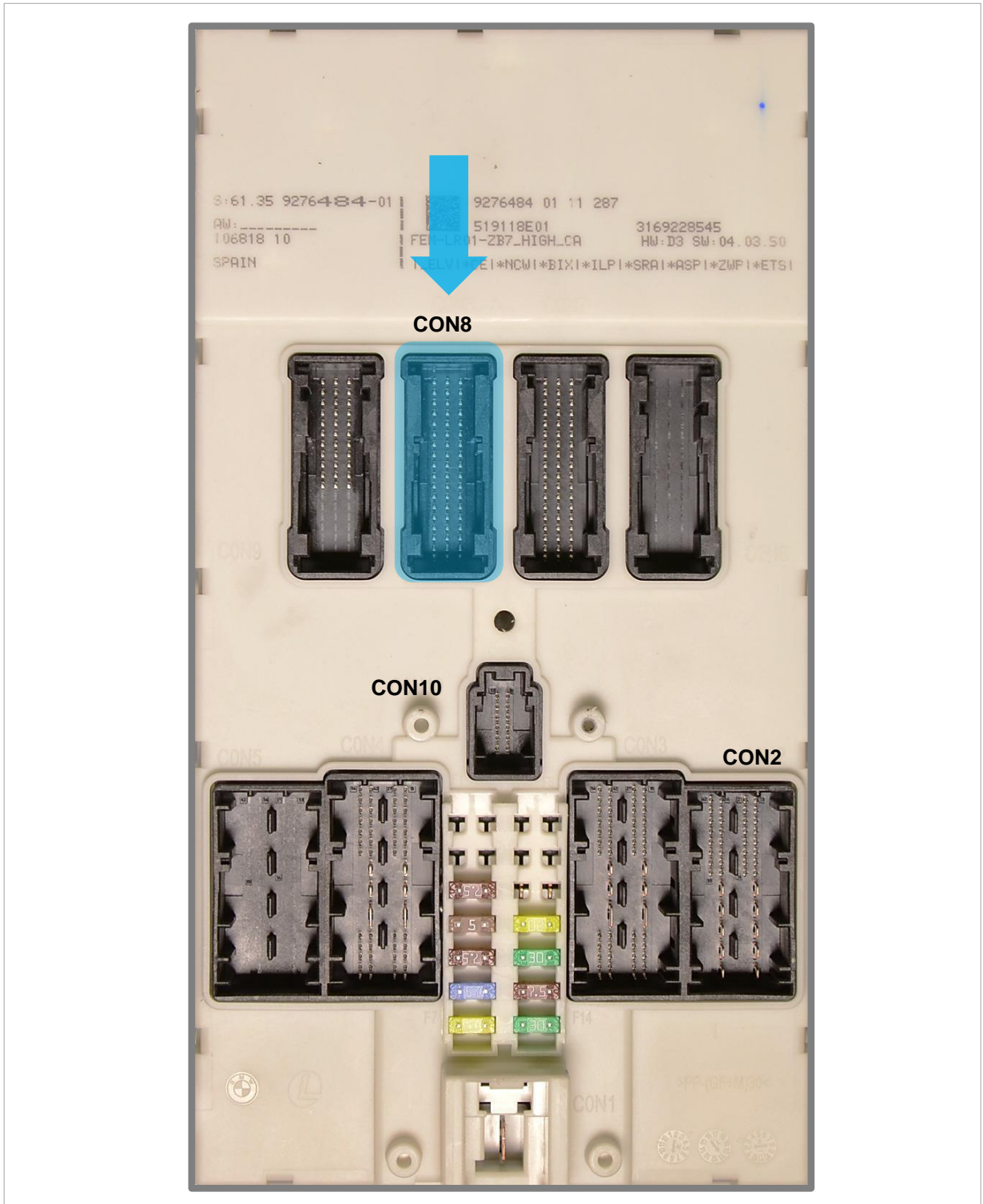

## Stecker CON 8 demontieren

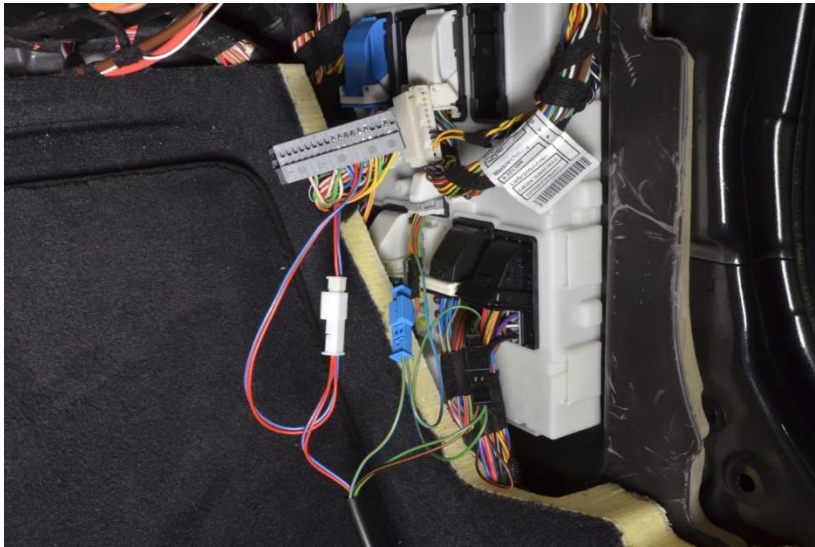

Kein Werkzeug notwendig

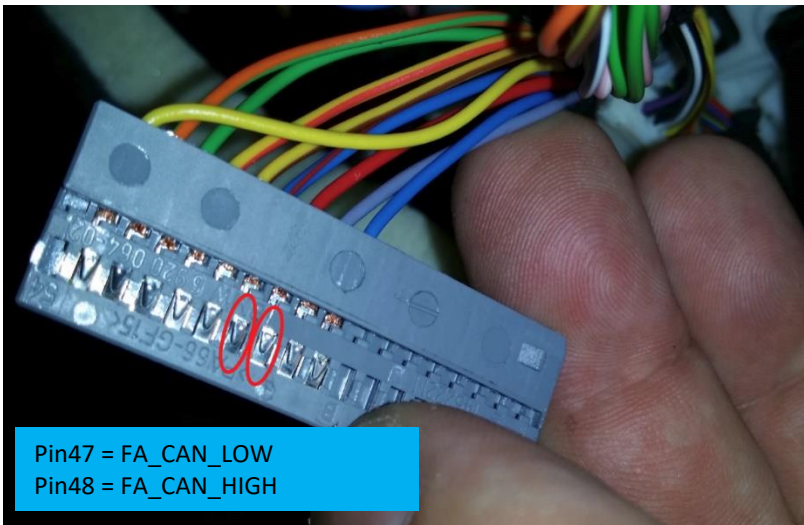

Kein Werkzeug notwendig

## FEM/BDC CON10

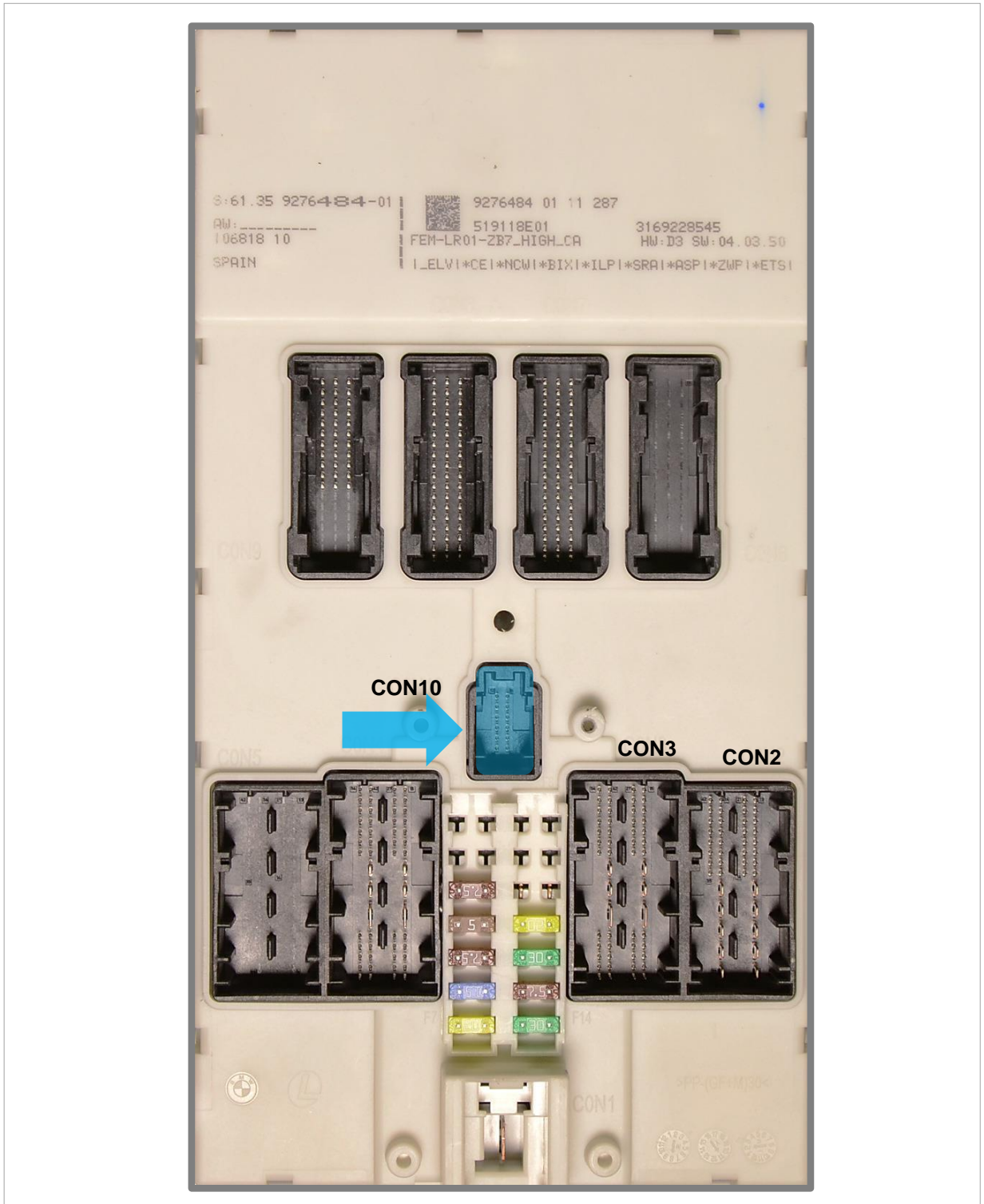

## Stecker CON 10 demontieren



Kein Werkzeug notwendig

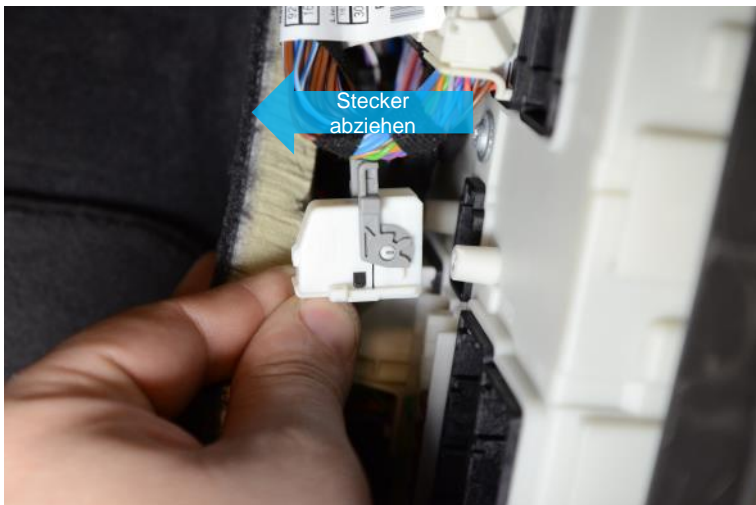

Kein Werkzeug notwendig



## Kabel aus Kammer ausspinnen

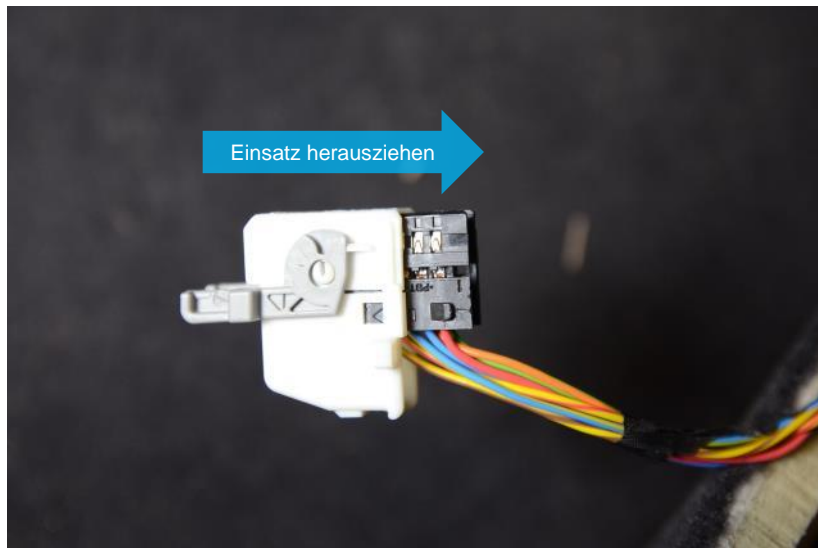

Kein Werkzeug notwendig

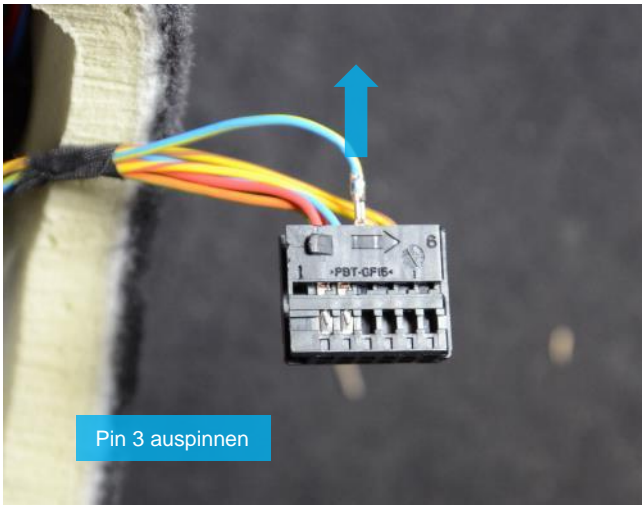

Flachschraubenzieher 2mm

## Kabel in Stecker pinnen und zusammenstecken

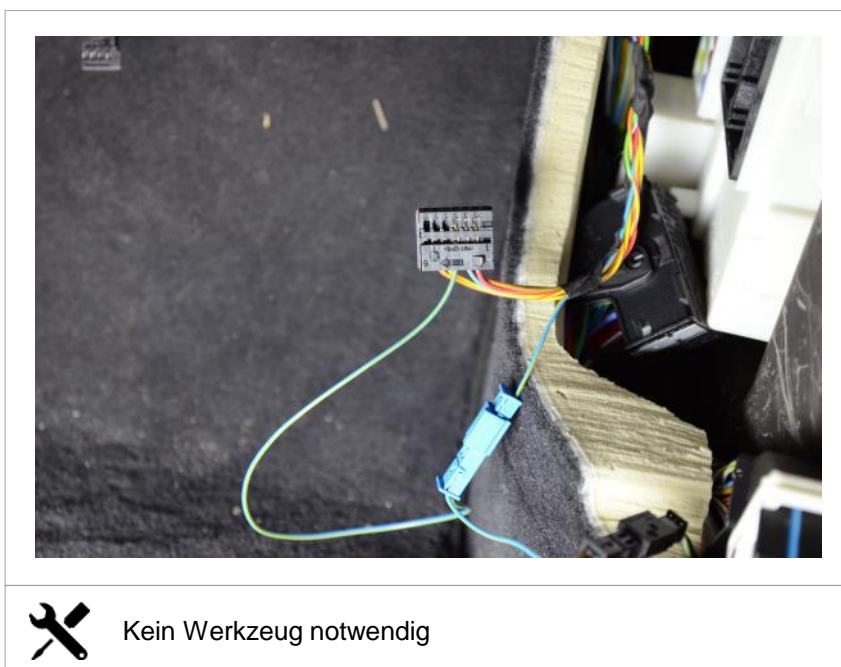

## Kontakt

---



AWRON-automotive  
Inh. Robert Sop  
Herbergstrasse 21  
80995 München  
Germany

Tel. +49 (0)89 37911860

E-Mail: [info@awron-automotive.de](mailto:info@awron-automotive.de)

Webseite: [www.awron-automotive.de](http://www.awron-automotive.de)